

## INTRODUCTORY LESSON

## WHAT MAKES A BIRD A BIRD?



## Big Idea

This month's activities provide a "bird's eye view" of what defines our feathered friends and introduces the idea of feeding birds while getting students on track to becoming enthusiastic bird experts.

## Learning Objectives

- Students will be able to name the features that make birds unique.
- Students will be able to identify three common bird species.

## Before You Start

Visit [www.birdsleuth.net/Pennington](http://www.birdsleuth.net/Pennington) to find background information and links to photo, video, and sound resources used in this lesson. We recommend you visit this site ahead of time to quickly orient yourself. Decide where you will conduct the "True or False" activity, and prepare to take students outside.

## THIS MONTH'S ACTIVITY

1

## True or False?

Students will confirm what they know (and dispel some myths) about birds via this active "True or False" game. If possible, set up a large space (outdoors, gym) or your classroom with a "True" and "False" side at opposite ends of the space. Invite students to run (or walk) from side to side depending on whether they think the statements you read are true or false. At the end of each statement, be sure to reveal the correct answer and if possible give an example. For examples visit [www.birdsleuth.net/Pennington](http://www.birdsleuth.net/Pennington).

## Basic Statements

1. Birds are the only living animals that have feathers.
2. All birds fly.
3. All birds have two wings.
4. Birds lose and replace their worn or damaged feathers.
5. All birds have thick, heavy bones that provide the structure they need to fly.
6. Birds have poor eyesight.
7. Birds have heartbeats that are slower than humans.
8. All birds lay eggs.
9. Most birds eat worms.
10. All birds sing.

Answers: 1.T 2.F 3.T 4.T 5.F 6.F 7.F 8.T 9.F 10.F



**Challenging Statements**

1. All birds migrate.
2. Birds are vertebrate animals.
3. All birds are warm blooded.
4. All baby birds hatch covered in downy feathers.
5. Male and female birds of some species look different.

Answers: 1.F 2.T 3.T 4.F 5.T



**Extension for More Advanced Groups**

You can extend the True/False activity by asking the students to defend their choices. If the group is split, ask each side to defend why they think they are right. Make it an option for students to consider their peer’s arguments and change their choice at any point during the debate.

**2 Meet Three Feeder Birds**

Introduce these bird species one by one to your students. Place the picture of the first bird on the board, or if you have a projector, pull up a larger image. As you show each species, ask:



**CHICKADEE**



**MOURNING DOVE**



**DOWNY WOODPECKER**

- Have you ever seen this bird before? Where did you see it?
- Do you know what its name is?
- Do you know what sound it makes? What does it sound like?
- How would you know it’s a \_\_\_\_\_?

Make a list of descriptive words the students use to describe each species on the board. If you can, add to the students’ experience by visiting [www.birdsleuth.net/Pennington](http://www.birdsleuth.net/Pennington) to show videos, hear sounds, and see more photos of each of the species. Ask students to try to mimic the sounds of the birds, especially the chickadee by saying “Chica dee dee dee.”

Photo Credits: The Mourning Dove by Evaristo Hernández-Fernández, and the Downy Woodpeckers by Larry McQueen

After all birds have been introduced, show the students all three birds together, and ask:

- If we saw/heard these species outside, how could we tell them apart? (How are they different?)
- What things do these birds all have in common?
- What makes birds unique (or different from other animals)?

Through these activities, students will essentially come up with their own list of “What makes a bird a bird?” Highlight the key points that all birds have feathers, two wings, two legs, hollow bones, beaks, and lay eggs.

### 3

## Take it Outside!

Now that you've learned the names of three common feeder birds (and what they look and sound like) take your students on a bird-watching adventure at the feeder for as little as 5-10 minutes. Try to find the three species, but if you don't, look and listen for other birds and other animals. Focus on the similarities and differences between the species you see. How do they look different? Sound different? Behave differently? Become more aware of birds, their behaviors, and their habitats. Now is a great time to get children in the habit of watching wildlife quietly! Visit the website to find tips about keeping students engaged and organized on trips outside.

### 4

## Take it Home!

Educators, keep students thinking about and observing birds at home by printing out the following pages (for a single two-sided copy) and sending them home with students. Invite the whole family to join the fun of watching birds!

*Print the following pages for each child to take home and let the education continue! ➡*

TAKE HOME ACTIVITY

Parents and Guardians - Your child has learned about wild birds in school, and this sheet is designed to offer more information and activities for your family to enjoy wild birds.

# WHAT MAKES A BIRD A BIRD?



## Birding in Your Neighborhood

Look for birds on a walk in your neighborhood, or sit quietly for 10 minutes to look and listen for birds. Consider the following questions:

- a) How many birds did you see? \_\_\_\_\_
- b) How many different kinds of birds did you see? \_\_\_\_\_
- c) Did you see any of the 3 species below? \_\_\_\_\_



CHICKADEE



MOURNING DOVE



DOWNY WOODPECKER

d) What were the birds doing? \_\_\_\_\_

e) Can you find a bird that is making noise?  Yes  No

*If you'd like, sketch one of the birds you see to share with your classmates!*

Photo Credits: Mourning Dove by Evaristo Hernández-Fernández, and Downy Woodpecker by Larry McQueen



## Cool Fact!

### IF IT HAS FEATHERS, IT'S A BIRD!

Birds are the only living creatures with feathers. Feathers are made of keratin, the same protein that makes up bird beaks, lizard scales, mammal hair, human fingernails, and animal hooves and horns! Feathers help birds fly and keep them warm and dry. The color patterns of feathers, called “plumage,” can help birds stay camouflaged or find mates.



## Pennington's Habitat Helpers

Shelter. Food. Water. Help birds with Habitat Helpers that you can buy or make.



A platform feeder is sturdy and great for attracting larger birds like jays and cardinals. These large and colorful birds are great fun to watch for people of any age or birding stage!

*Next Month: Make your own Platform Feeder. We'll show you how!*



## Cornell Lab's Book of the Month

### WHAT MAKES A BIRD A BIRD?

by May Garelick



Beautifully illustrated, this book sparks the imagination and teaches more about bird basics.

Visit our website at [www.birdsleuth.net/Pennington](http://www.birdsleuth.net/Pennington) to order a copy.

Visit [www.facebook.com/PenningtonBirds](http://www.facebook.com/PenningtonBirds)

# WHAT'S IN A HABITAT?



## Big Idea

Habitat provides the four essential components all animals need to survive: food, water, cover, and space.

## Learning Objectives

- Students will be able to list the four components of a habitat.
- Students will be able to identify at least three effects that humans have on the environment.

### Before You Start

Gather materials needed to draw/sketch. You may include clipboards, blank paper, pens, pencils, crayons, etc. Prepare to take your students outside. Visit [www.birdsleuth.net/Pennington](http://www.birdsleuth.net/Pennington) for more information.



## Bird of the Month!

This month's bird is an **American Goldfinch**! The males and females of this species have different coloration, so be sure to point out the brightly-colored males and the less striking females.

Visit [www.allaboutbirds.org/guide/American\\_Goldfinch/id](http://www.allaboutbirds.org/guide/American_Goldfinch/id) for more information and images to share with your students.

## THIS MONTH'S ACTIVITY

# 1

### Habitat

Ask your students what they think a habitat is. Make a list of all definitions or words students mention.

Next, if they have problems narrowing it down, use this definition: A habitat is a place that gives a group of plants and animals what they need to live.

Now have students discuss what makes up a habitat, knowing it's a place that meets the needs of plants and animals. You can compare it to where they live and what they need to survive: food, water, cover, and space (the four habitat components). *Cover* refers to shelter and can include nesting areas, places to sleep or rest, and places to hide or escape. *Space* means the amount and kind of area needed to hunt, feed, and live as well as migration routes for some species.

Photo Credit: American Goldfinch photographed by Keith Bowers

Ask: How are the needs of specific bird species different? (i.e. a chickadee versus a hawk, a heron or duck. Check out the bird profiles on [www.allaboutbirds.org/guide/browse](http://www.allaboutbirds.org/guide/browse) for more detail on habitat needs for specific bird species.)

Next, using one of these bird examples, go through each of the four habitat components. What happens if you take away a needed element of the habitat? (If a place doesn't provide the right food, water, and cover in the right arrangement for a particular species, the bird can't live there.)

### *Human Effect: Pollution*

Ask: What is pollution? Make a list of the words students mention and make a list of locations they say can be polluted. (i.e. garbage, oil spills/ locations: water, air, ground.) Then, define it: pollution is the presence of a substance or thing in the environment that is harmful or poisonous. Express how living things cannot survive without clean water, air, and land. Tell your students that birds are very sensitive to pollution and ask:

- How do you think pollution affects animals?
- What do you think you can do to try and help keep habitats from being polluted? (The most common answers are to pick up garbage, but encourage them to think about other things like not letting buses or cars idle and pollute the air.)

2

## Take a Schoolyard Field Trip!

Take your students outside. Bring supplies for drawing. You and your students will spread out quietly to draw the schoolyard and label sources of food, water, and cover for a bird.

Next, bring the whole group back together and discuss the food, water, cover and space they drew. Ask:

- What kind of food, water, and cover is available here for birds? What kinds of birds might live here?
- Is there something we could do to make it a more complete habitat for birds? (Put in a feeder or birdbath, clean it up, plant native plants, etc.)
- Is there pollution on your school grounds? If so, what could we safely do to clean up the area?

### *For Advanced Groups*

*To encourage stewardship of the local environment, organize a schoolyard or park cleanup. Consider asking businesses to donate things like rubber gloves and garbage bags.*

3

## Take it Home!

Educators, keep students thinking about and observing birds at home by sending copies of the next pages (for a single two-sided copy) home with students. Invite the whole family to join the fun of watching birds!

*Print the following page for each child to take home and let the education continue! ➡*

**TAKE HOME ACTIVITY**

Parents and Guardians - Your child has learned about wild birds in school, and this sheet is designed to offer more information and activities for your family to enjoy wild birds.

# WHAT'S IN A HABITAT?

Create a map of your yard with the help of an adult. No yard? No problem. You can map a public park or area nearby. Spend time observing what is there. Are there any trees, gardens, structures, or standing water in the yard? Where are these objects? Are there any flowering plants, shrubs, a lawn, bird feeders? Can you identify any of the plants? (If not, that's ok! A brief description will suffice.) After an initial survey of the yard, create a labeled map of the space.

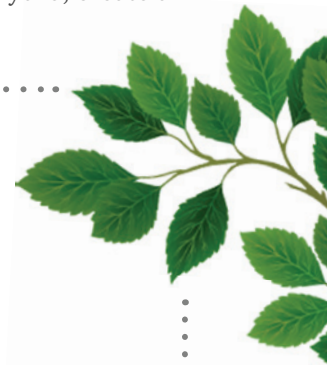





## Cool Fact!

### BE CAREFUL WHAT YOU SPRAY!

Back in 1970, times were looking tough for a large variety of bird species including Bald Eagles and Peregrine Falcons. Why? Because a pesticide called DDT had polluted bird habitats and caused the birds to lay eggs with weak shells. These effects caused populations of both birds to diminish by more than 80%. Peregrine populations were so low that no nesting pairs could be found within the eastern US. With the ban of DDT and rigorous bird restoration programs developed in part by the Cornell Lab of Ornithology, these birds were able to make a sweeping comeback.



## Pennington's Habitat Helpers

Shelter. Food. Water. Help birds with Habitat Helpers that you can buy or make.

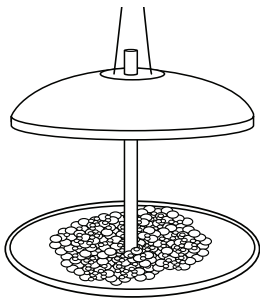

### Platform Feeder

Blue Jays and Cardinals are big fans of platform feeders. Create one yourself! It's pretty simple! To make the easiest platform tray, all you need is an old frisbee, cookie tray, clementine crate... anything with a strong base and a rim at least an inch high to contain the seed and allow birds to perch. Next, mount the platform by attaching it to a sturdy pole and staking this into the ground. Attaching rope around the stand and hanging it from a tree is another option.



## Cornell Lab's Book of the Month ON MEADOWVIEW STREET

by Henry Cole

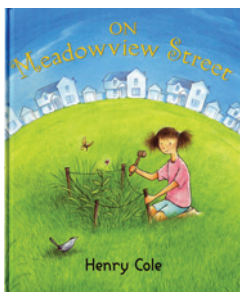

Caroline has just moved to Meadowview Street. But where's the meadow? Henry Cole tells a wonderful story of a 'lawn' that becomes 'habitat' for all kinds of interesting creatures and beautiful birds.

Learn more at [www.birdsleuth.net/Pennington](http://www.birdsleuth.net/Pennington)



Visit [www.facebook.com/PenningtonBirds](http://www.facebook.com/PenningtonBirds)

# TAKING FLIGHT – FLYING AND MIGRATION

## Big Idea

Birds are the vertebrate commanders of the sky: soaring, swooping, gliding, and hovering—most birds get from place to place through flight. In this activity, students explore the basic principles of flight and learn why some birds migrate.

## Learning Objectives

- Students will be able to describe why some birds soar.
- Students will be able to describe at least three hazards that migrating birds face.

### Before You Start

Jot down a list of additional migration hazards for the migration game (STEP FORWARD: favorable winds, plenty of insects, plenty of water, good habitat. STEP BACK: left late, strong headwind, stopover habitat is poor, get sick on the way, inexperienced migrator. SIT DOWN: Killed in a blizzard, ran into a cell phone tower, starvation.)

**Optional:** Check out some background information about migration at [www.birdsleuth.net/Pennington](http://www.birdsleuth.net/Pennington).



Blue Jay



Steller's Jay

## Birds of the Month!

There are two birds this month! The **Blue Jay**, found on the East Coast, and the **Steller's Jay**, found on the West Coast. These birds' vibrant blue coloration and aggressive disposition are hard to miss at feeders and in schoolyards.

Visit [www.allaboutbirds.org/guide/blue\\_jay/id](http://www.allaboutbirds.org/guide/blue_jay/id) and [www.allaboutbirds.org/guide/Stellers\\_Jay/id](http://www.allaboutbirds.org/guide/Stellers_Jay/id) for more information and images to share with your students.

## THIS MONTH'S ACTIVITY

### 1 Take Wing

Once they get up in the air, birds like Turkey Vultures and eagles use their wings to soar. This helps the birds save energy in flight! Part 1 of this activity demonstrates how birds save energy while flying, while Part 2 demonstrates how challenging migration is for birds.

Photo Credit: Blue Jay photographed by Katya Porter; Stellar's Jay photographed by Gary Witt



You and your students will begin by standing in place and practicing flapping your “wings” (arms) for 20 seconds. When time is up, talk about how that felt. (Probably tiring!) Ask: If you had to flap your wings all the way home, could you do it? (Probably not!) Next, stand up and hold your “wings” out for 20 seconds, rocking gently side to side like a soaring eagle. How did it feel this time? Was soaring easier or harder work than flapping? Would you prefer to fly to school by flapping your wings or soaring?



Now try the exercise again, but this time holding canned goods or some sort of weight in each hand. The heavier you are, the harder it is to fly! This is why it is important that birds have hollow bones.

## 2 Migration Game

Ask students if they know where some birds go in the winter. Explain that some stay put, while others travel between breeding and wintering grounds. They *migrate*. In this game there will be both hazards and triumphs.

Tell your students that everyone in the class is a bird migrating south to spend the winter!

Have everyone start at the “north” end of the room and progress “south” for a successful migration. To run the activity, choose a characteristic of the students (i.e. wearing sneakers) and choose an event (suggestions below) that makes them step forward, step back, or sit down. For example, anyone wearing a watch ran into a building, is dazed, and takes a step back. Once a student sits down, he or she fails to safely migrate. End the game when about half the kids are still standing and emphasize how challenging migration is for real birds.



### STEP FORWARD:

- Favorable Winds
- Plenty of Insects
- Plenty of Water
- Good Habitat

### STEP BACK:

- Left Late
- Strong Headwind
- Stopover Habitat is Poor
- Get Sick on the Way
- Inexperienced Migrator

### SIT DOWN:

- Killed in a Blizzard
- Starvation
- Ran into a Cell Phone Tower

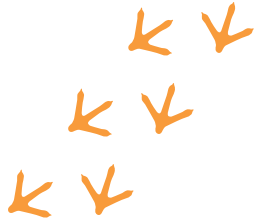

At the end of the game, ask students what they thought of the migration trip with these follow-up questions:

- What were some of the negative things that happened? Why were there so many obstacles?
- Some of the positive things? What things could humans help with?
- What are some birds that do not migrate (resident birds)?
  - Northern Cardinal: Eastern North America
  - Black-capped Chickadee: Northern North America
  - House Sparrow: All of North America, Western coastline and Eastern side of South America
  - Downy Woodpecker: All of North America above Mexico
  - Tufted Titmouse: Eastern half of the United States
- Can you think of an animal besides a bird that migrates? (Monarch Butterfly, Caribou, Whales).



### Take it Outside!

Grab a blanket to lie on or find a soft patch of grass and spend 15 minutes outside looking at the sky. Do you see any birds up in the air? Do all birds fly the same? If not, how are they different?

### 4

### Take it Home!

Educators, keep students thinking about and observing birds at home by sending copies of the next pages (for a single two-sided copy) home with students. Invite the whole family to join the fun of watching birds!

*Print the following page for each child to take home and let the education continue! →*

**TAKE HOME ACTIVITY**

Parents and Guardians - Your child has learned about wild birds in school, and this sheet is designed to offer more information and activities for your family to enjoy wild birds.

# TAKING FLIGHT – FLYING AND MIGRATION

Experiment with flight at home by playing with paper airplanes. Find some scrap paper and a table and get folding! Once you test a few standard designs of paper airplanes, start mixing up the design. How will different material, shape, and size affect the plane's flight? What happens if you cut the ends of the wings in a zig-zag shape or throw the plane into or away from a headwind? Jot down and share your observations. Next, reuse the paper by cutting out a bird silhouette and taping it to a large window as an ornament. This will save paper and could save the lives of birds that might have otherwise crashed into your window by accident.



## Cool Fact!

### THE FARTHEST FLIER

The Arctic Tern makes the longest migration of any bird as it flies from one side of the globe to the other on an annual journey that can end up being more than 25,000 miles! Their migration route begins in Canada, where they breed, and ends in Antarctica every year for winter.

Because an Arctic Tern can live to age 34, it is likely some have flown more than 800,000 miles in a lifetime! Visit [www.allaboutbirds.org](http://www.allaboutbirds.org) to learn more!



## Pennington's Habitat Helpers

Shelter. Food. Water. Help birds with Habitat Helpers that you can buy or make.



### Squirrel Proof Feeder

Sorry squirrels, this feeder is just for birds! It features a chew proof hanging cable and a rust resistant base and seed ports. It is easy to fill and hang, and can hold up to 3 lbs.

**Next month:** With an adult, make a wild bird treat that can hang on outdoor trees like an ornament. We'll give you step-by-step instructions for this fun, family craft activity that also feeds the birds.



## Cornell Lab's Book of the Month

### ANIMALS IN FLIGHT

by Steve Jenkins and Robin Page



In this book, find out the how, when, and why birds and other animals take flight.

Learn more at [www.birdsleuth.net/Pennington](http://www.birdsleuth.net/Pennington)

Visit [www.facebook.com/PenningtonBirds](http://www.facebook.com/PenningtonBirds)

# MOVE LIKE A BIRD!

## Big Idea

Birds get around in different ways, and these movements are interesting to observe.

## Learning Objectives

- Students will be able to recognize and demonstrate at least three differences in the ways that birds move.

### Before You Start

Visit [www.birdsleuth.net/Pennington](http://www.birdsleuth.net/Pennington) to find the recommended video clips of bird movement. Practice calling for the “Birdy Says” game (on next page) so it goes smoothly and quickly.

## Bird of the Month!

This month’s bird is the **American Crow**. Found almost all over the country, these black birds don’t usually come to feeders but they love peanuts! Try leaving some out in an open area and see if they’ll come!

Visit [http://www.allaboutbirds.org/guide/American\\_crow/id](http://www.allaboutbirds.org/guide/American_crow/id) for more information and images to share with your students.



## THIS MONTH’S ACTIVITY

### 1 Move Like A Bird

#### Ask students:

- How do birds get around? (Fly, walk, swim, hop, soar, flap, migrate)
- Do all birds fly, walk, and swim the same way? What are some differences you have observed?
- Why do birds move? (Find food, get away from predators, find mates)

Project the videos of the soaring **Golden Eagle**, long-legged **Ostrich**, running **American Robin**, and swimming **Common Loon**. After each video ask a student to try and imitate the bird’s movement. Ask other students if they think their classmate’s imitation is accurate and what makes it look like the bird. Or what could they do differently to make it more accurate? (i.e. “he is taking very small fast steps” or “she is hopping!”)

Photo Credit: American Crow photographed by Marcus Smith

2

## Take it Outside!

Demonstrate the five movements the kids will use in a version of “Simon Says,” except call it “Birdy Says!”



### CITY STRUT

Moving their heads in and out as they walk, students put their hands behind their backs, take short steps, and imitate a pigeon.

### DESERT SOAR

Like vultures, students spread their arms and gently tip their bodies and arms back and forth.

### SHUFFLE-SHUFFLE

Ask students to do their best “penguin” by holding their arms at a slight angle away from their bodies and shuffle with small steps and feet close together. A little swaying adds to the waddle.

### FLIT-AROUND

Acting like the little helicopters hummingbirds are, students flap their arms from their elbows as fast as possible and hover in one position. They can also fly up or down or even side-to-side.

### STEP-STOP

Just like robins, students step, step, step then stop to listen for worms.

After you demonstrate, go through each of the movements with the whole class. Once they have each name and movement down, play “Birdy Says!”

Explain the rules: You will call out one of the five movements or tell them when you say “Cooper’s Hawk!” (a bird of prey that is a potential threat) they must freeze! Players can only do what you say if you start with “Birdy says \_\_\_\_\_.” Anyone who moves when you call something out without “Birdy says” must take a seat. Additionally, if someone does the wrong movement, they also must take a seat!

3

## Take it Home!

Educators, keep students thinking about and observing birds at home by sending copies of the next pages (for a single two-sided copy) home with students. Invite the whole family to join the fun of watching birds!

*Print the following pages for each child to take home and let the education continue! ➡*

**TAKE HOME ACTIVITY**

Parents and Guardians - Your child has learned about wild birds in school, and this sheet is designed to offer more information and activities for your family to enjoy wild birds.

# MOVE LIKE A BIRD!



## Walk the Walk?

Check off the bird movements you see in your neighborhood!

### CITY STRUT

Bird moves its head in and out as it walks.

### DESERT SOAR

Wings spread, the bird's body and arms rock back and forth.

### SHUFFLE-SHUFFLE

The bird shuffles in small steps with its feet close together and wings at a slight angle.

### FLIT-AROUND

Wings flap as fast as possible as the bird hovers in one position.

### STEP-STOP

Bird that steps, steps, steps then stops to listen for worms.



## Cool Fact!

### NOW WHERE DID I PUT THAT?

Many birds like to cache their food: that means they store food when abundant so that later when they can't find any, they have reserves. Birds like to keep a little in many different hiding places, so if it's discovered by another animal, not all the food will be lost. This also means needing to remember where the hiding places are. But that's no problem for the Western Scrub-Jays! They can remember up to 200 different hiding places and what's in each hiding place.

Visit [www.allaboutbirds.org](http://www.allaboutbirds.org) to learn more!





## Pennington's Habitat Helpers

Shelter. Food. Water. Help birds with Habitat Helpers that you can buy or make.

### *Homemade Wild Bird Ornament Treats*

Brr! Winter can be tough for birds. But you can help birds out by making and hanging ornament treats in your trees outside.

#### INGREDIENTS

Pennington® Songbird Ornaments  
(no cooking required)

3/4 cup flour

1/2 cup water

3 tablespoons corn syrup (or pancake/maple syrup)

4 cups Pennington® Bird Feed



- 1) Mix ingredients.
- 2) Press tightly into cookie cutters with spoon or handle.
- 3) Insert straw or pencil to create hang hole.
- 4) Let dry for 4-6 hours or overnight, remove from cookie cutter, pressing mixture out from sides.
- 5) Insert string into hang hole (consider using natural fibers or yarn so birds can also use in their nests).
- 6) Hang outdoors for birds to enjoy.



## Cornell Lab's Book of the Month

### BIRD WATCH

by Jane Yolen



A soaring collection of poems about birds.

Order a copy at [www.birdsleuth.net/Pennington](http://www.birdsleuth.net/Pennington).

Visit [www.facebook.com/PenningtonBirds](https://www.facebook.com/PenningtonBirds)

# EAT LIKE A BIRD!

## Big Idea

Bird beaks come in many different sizes and shapes. Each beak has a specialized shape and function to help that species get and eat the food they consume.

## Learning Objectives

- Students will be able to name at least three foods that birds eat.
- Students will be able to name three adaptations birds have for survival.



### Before You Start

Try to collect a representation of the following materials: sunflower seed, bird seed, nuts (such as walnuts and peanuts, in the shell), flower, fruit, fish, insects, worms, small animal. These can be the real thing, pictures, or stuffed or plastic animal replicas to help the students visualize the variety of food available to birds.

## Bird of the Month!

This month's bird is a **Dark-eyed Junco**! A unique way to remember this bird is by its white belly that has given it the nickname "Snow Bird." This is a very common bird you will see at your feeder in winter!

Visit [www.allaboutbirds.org/guide/Dark-eyed\\_Junco/id](http://www.allaboutbirds.org/guide/Dark-eyed_Junco/id) for more information and images to share with your students.



Photo Credit: Dark-eyed Junco photographed by Unknown

## THIS MONTH'S ACTIVITY

1

### Food Detectives

Start this activity by brainstorming the variety of foods that birds eat and writing answers on the board (various seeds, nuts, flower nectar, fruit, berries, fish, insects, worms, small animals). Then present your students with at least five various types of foods (see list above). Look at the food items one at a time, ask your students the following questions for each type:

- 1) Where would you find this kind of food?
- 2) If you are a bird, what are the challenges to getting this food?
- 3) What kinds of tools might you (as a person) need to get and eat the food more easily? (Fingers, a spoon, tweezers, nutcracker, etc.)
- 4) How might a bird's beak be shaped to get and eat this food? (You might wish to ask students to draw and share their response.)

### *For Advanced Groups*

*Have students break up into groups and answer the final question in small teams. At the end, compare each groups' final drawings.*

*If possible, show your students images or videos of birds that actually eat each of these foods. Some are posted at [www.birdsleuth.net/Pennington](http://www.birdsleuth.net/Pennington).*

2

### Take it Outside!

What type of bird visits your schoolyard feeder depends on the type of food you provide. Consider doing an experiment in which you set out an identical feeder with different types of feed. Another option is to switch the feed in your current feeder for a couple of weeks and see how that impacts the birds that visit. If you don't have a feeder, you can simply take a few peanut butter covered pinecones and roll each one in various types of seed. This experiment will get your students thinking about how the birds visiting the feeder have preferences about what they eat. Make observations with the class and keep data on the "I Wonder" board!

3

### Take it Home!

Educators, keep students thinking about and observing birds at home by sending copies of the next pages (for a single two-sided copy) home with students. Invite the whole family to join the fun of watching birds!

*Print the following pages for each child to take home and let the education continue! →*

**TAKE HOME ACTIVITY**

Parents and Guardians - Your child has learned about wild birds in school, and this sheet is designed to offer more information and activities for your family to enjoy wild birds.

# EAT LIKE A BIRD!



## The Beak Game

Gather together any of the following supplies you can find at home to represent the real food birds eat:

### FOOD RESOURCES:

Macaroni (small animals), goldfish crackers (fish), gummy worms (earth worms), chocolate sprinkles (ants), peanuts, sunflower seeds, raisins, mini-marshmallows (grubs/caterpillars), dry cereals (insects), fruit juice (nectar)

### BEAKS (UTENSILS):

Clothespin, toothpick, straw, spoon, small plastic scoop, tweezers/small scissors

Hold one type of "beak" in one hand and keep the other hand behind your back. With one type of food in front of you, try and gather as much food as possible in 15 seconds. Keep in mind: your survival depends on your ability to gather food! After 15 seconds is up, try another beak and gather food for another 15 seconds. Repeat the procedure for each type of beak.

Which beak was most successful in gathering which types of food?

Birds have beaks like the tools you used in this activity. Can you match the shape/function of any of the tools with real beaks? The shape of a bird's beak is critical for its survival because it provides access to food. Next time you see a bird, take a look at its beak and see if you can tell what it eats! Remember: Different beaks are better suited for different foods.



## Cool Fact!

### AMERICAN ROBIN

American Robins eat large numbers of both invertebrates and fruit. Particularly in spring and summer, they consume earthworms as well as insects and some snails. Robins also eat an enormous variety of fruits, including chokecherries, hawthorn, dogwood, and more. One study suggested robins may try to round out their diet by selectively eating fruits that have bugs in them.

Visit [www.allaboutbirds.org](http://www.allaboutbirds.org) to learn more!



## Pennington's Habitat Helpers

Shelter. Food. Water. Help birds with Habitat Helpers that you can buy or make.



### *Pennington Suet*

It's getting cold! Keep chickadees, mockingbirds, robins, and nuthatches warm with this ideal energy source.

**Next month:** *Build your own perching feeder. We'll show you how!*



## Cornell Lab's Book of the Month **BEAKS!**

by Sneed B. Collard III

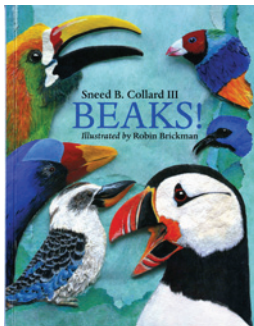

In this book, students will explore a wonderful variety of bird beaks and how they relate to what birds eat.

Order a copy at [www.birdsleuth.net/Pennington](http://www.birdsleuth.net/Pennington).

Visit [www.facebook.com/PenningtonBirds](https://www.facebook.com/PenningtonBirds)

# IF YOU CAN COUNT, YOU CAN HELP A SCIENTIST!

## Big Idea

The Great Backyard Bird Count (GBBC) takes place during February of each year; your students can count birds and submit data that will help scientists. This year's GBBC is February 15-18, 2013.

## Learning Objectives

- Students will become expert at identifying a particular species of bird.
- Students will be able to collect data for the GBBC citizen science project.
- Students will be able to describe “citizen science” and its importance.

### Before You Start

Visit the Great Backyard Bird Count website to get familiar with the event and how to participate. Carefully review the details about how to conduct and submit counts. Print your regional bird checklist to get an idea of the kinds of birds you're likely to see in your area in February.

Visit [www.birdsleuth.net/Pennington](http://www.birdsleuth.net/Pennington) for links and resources.



## Birds of the Month!

Two very similar-looking birds, the House Finch and the Purple Finch, share this month's spotlight. You'll have to get close to tell them apart; the House Finch's red is more vivid, and its top beak has a bit of a curve to it.



House Finch



Purple Finch

Visit [www.allaboutbirds.org/guide/House\\_Finch/id](http://www.allaboutbirds.org/guide/House_Finch/id) and [www.allaboutbirds.org/guide/Purple\\_Finch/id](http://www.allaboutbirds.org/guide/Purple_Finch/id) for more information and images to share with your students.

Photo Credit: House Finch photographed by Don Rash; Purple Finch photographed by Tom Smith

## THIS MONTH'S ACTIVITY

1

### Become a Bird Expert

Write the words, “citizen science” on the board. Ask your students what they think this means. Explain that in citizen science projects, people help scientists with studies on everything from birds to butterflies (see the “cool fact” for information). Explain that the Great Backyard Bird Count (GBBC) is an annual four-day event that engages thousands of bird watchers across the continent. This creates a real-time snapshot of where birds are. Anyone can participate, from beginning bird watchers to experts, but it is important for everyone to identify and count the birds accurately.

In preparation for the GBBC, assign each student to become an expert in identifying one local bird so that he or she can help the group find, identify and count that bird. This way your whole class will learn a dozen or more birds together! First, each student will draw and color the bird. Then, he or she will add drawing details such as: what the bird eats, the sounds it makes, and the distinguishable features used to identify it. Have your students present their drawings to the class so everyone learns the birds.

#### *For Advanced Groups*

*With older students, you might want to spend more time on this and have it be a small, independent research project. Allow them to access [AllAboutBirds.org](http://AllAboutBirds.org), other websites, or the library to create a full report about their bird. Encourage your students to compare their birds to each other's and with a bird that looks similar, and share how they are distinguishable.*

2

### Great Backyard Bird Count

Plan to count birds for at least 15 minutes on one or more days of the count. Over the four days of the GBBC (February 15-18), count birds in as many places and on as many days as you like. Submit a separate checklist for each new day/location. Remember, each person tallies the greatest number of individuals of each species he or she sees together at any one time. Then, compile your class results (i.e. the highest count anyone in the group has seen) into one checklist to submit. Enter your results on the GBBC website before the March 3rd, 2013 deadline (which is a couple of weeks after the count).

Follow up with the class by asking your students how they think their counts will contribute to science. (*For example, these counts help track changes in bird populations from year to year.*)

## 3

## Take it Outside!

You've been watching the birds for the GBBC, but you might be wondering... how might birds watch you? Birds have better eyesight than humans. Some have eyes on either side of their head. This leads to monocular vision and means they can easily see an object with only one eye at a time. Other species have eyes in the front of their head, like humans do. This leads to binocular vision; seeing an object with both eyes at once. Go outside with your class and bring a tennis ball or other small, soft ball. Have students toss around the ball with one eye covered (monocular vision). Then have them toss the ball with both eyes open. Ask:

- Which was easier? Why?
- Raptors have good binocular vision. What other animals (birds or other) have binocular vision? (*Owls, humans, dogs, green herons and many more. Hammerhead sharks, on the extreme end, have eyes that allow for 360 degrees of vision and binocular vision.*)
- Why is binocular vision helpful for raptors and these animals? What do these animals have in common, if anything? (*These tend to be predators; they need to focus in on prey ahead of them, and need good depth perception for the hunt.*)
- Why do some animals have monocular vision? (*These tend to be prey animals; they can see better all-around their bodies.*)

## 4

## Take it Home!

Educators, keep students thinking about and observing birds at home by sending copies of the next pages (for a single two-sided copy) home with students. Invite the whole family to join the fun of watching birds!

*Print the following pages for each child to take home and let the education continue!*



**TAKE HOME ACTIVITY**

Parents and Guardians - Your child has learned about wild birds in school, and this sheet is designed to offer more information and activities for your family to enjoy wild birds.

# IF YOU CAN COUNT, YOU CAN HELP A SCIENTIST!



## Flying Bird Silhouettes

Both birds with monocular and binocular vision have a common problem - they cannot easily see glass! Thousands of birds every year die from flying into glass windows. There are many ways to prevent it and one of the easiest is to hang objects in the window, or attach them directly to the glass. With an adult, cut out shapes from paper and stick them to your windows, especially large windows. Follow the steps below for an easy and fun way to make flying bird silhouettes:

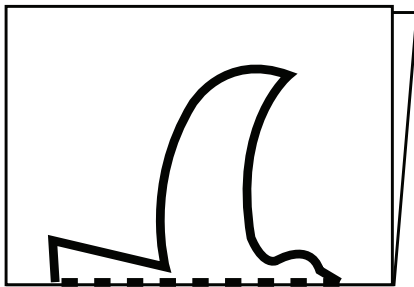

- 1) Fold a piece of colored paper in half.
- 2) On the folded side draw the following outline (or something similar) where the dashed line is the side with the fold.
- 3) Then cut it out and unfold it...You have a bird shape!

This is a very basic outline, but experiment and see how creative you can make it!



## Cool Fact!

### CITIZEN SCIENCE IS IMPORTANT—AND YOU CAN TAKE PART!

Citizen Science is a partnership between the public and professional scientists, which can help answer questions scientists alone couldn't answer. Our citizen scientists help with research tasks such as observation and data collection, such as the kinds, numbers, and behaviors of birds.

In 2010, volunteers—including some beginning birders like you—contributed more than 1.3 million hours to eBird, watching for birds and keeping track of them on checklists. 1.3 million hours is 148 years, nonstop. Scientists could never have been able to collect all that data from all around the world without the help of citizen scientists!



## Pennington's Habitat Helpers

Shelter. Food. Water. Help birds with Habitat Helpers that you can buy or make.

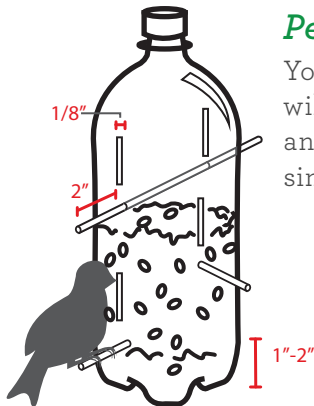

### Perching Feeder

Your winged friends will love perching on and feeding from this simple feeder.

### SUPPLIES NEEDED:

- Clean 1-liter soda bottle
- Craft knife (adult use only)
- 2 wooden dowels
- Small eye screw
- Twine/string for hanging



### INSTRUCTIONS:

- 1) Draw a 1/2-inch asterisk on the side of a clean 1-liter soda bottle (about 4 inches from the bottom).
- 2) Rotate the bottle 90 degrees and draw another asterisk 2 inches from the bottom.
- 3) Draw a 1-inch-wide circle opposite each asterisk.
- 4) Use a craft knife to slit the asterisk lines and cut out the circles (an adult's job).
- 5) Insert a wooden dowel first through each hole and then through the opposite asterisk.
- 6) Remove the bottle cap and twist a small eye screw into the top of it for hanging.
- 7) Fill your feeder (the bottle) with bird seed, recap it, and use a length of twine to hang it from a tree.



## Cornell Lab's Book of the Month

### THE BOY WHO DREW BIRDS

by Jacqueline Davies

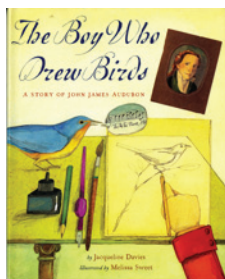

The story of John James Audubon, a pioneer in North American birding who grew up drawing birds and following his curiosity.

Learn more at [www.birdsleuth.net/Pennington](http://www.birdsleuth.net/Pennington)

Visit [www.facebook.com/PenningtonBirds](https://www.facebook.com/PenningtonBirds)

# WHO'S THAT... UP IN THE SKY?

## Big Idea

By learning the basic types of birds, anyone can learn to identify species and submit their observations to a citizen-science database.

## Learning Objectives

- Students will be able to identify silhouettes of eight different types of birds.
- Students will be able to compare birds they see outside to their “Common Feeder Birds Poster.”



### Before You Start

Visit [www.birdsleuth.net/Pennington](http://www.birdsleuth.net/Pennington) to print the mini-posters used in this lesson. Select the appropriate Project FeederWatch mini-poster based on your location, then print and hang it in your classroom. Also print or project the “Bird Silhouettes” mini-poster or large individual versions of each bird to use within the lesson.

Log into eBird to register for a new user account for your class. Visit [www.birdsleuth.net/Pennington](http://www.birdsleuth.net/Pennington) to learn how to make and maintain an ebird account.

## Bird of the Month!

This month's bird is a **House Sparrow**, a bird so common that you might have even stopped noticing it. Aside from finding them at your feeder, you might also find them on the ground taking dust baths!

Visit [http://www.allaboutbirds.org/guide/House\\_Sparrow/id](http://www.allaboutbirds.org/guide/House_Sparrow/id) for more information and images to share with your students.



Photo Credit: House Sparrow photographed by Robert J. Baker

## THIS MONTH'S ACTIVITY

1

### Silhouettes



Goose

Shorebird

Woodpecker

Owl

Hummingbird

Perching Bird

Duck

Bird of Prey

By learning these 8 basic silhouettes of birds, even the newest birder can begin to separate species they see into bird groups. This narrows them down for proper identification.

Ask: Which is the goose? The owl? Hummingbird? ...etc.

Next, inquire: How did you know? Make lists of characteristics of each (for example, a goose has a long neck and shorebirds have long legs). Ask, which kinds of birds do you think we would see at our feeder?

2

### Common Feeder Birds

Show your students the Common Feeder Birds mini-poster (ideally it is by the window or in a location where they can easily and quietly reference it while watching the feeder). If you do not have a feeder viewable from inside, we suggest attaching it to a piece of cardboard so that it is portable to take outside to view the feeder. Let them watch for as little as 5-10 minutes to practice identifying birds and bird groups.



3

### Take it Outside!

eBird is an amazing tool that has created a network to monitor birds around the globe. It provides a great opportunity to help collect and report data for REAL science. We encourage you to continue using eBird by allotting time once a day, week, or month to watch for birds and record your sightings. This is a great way to get students excited and engaged with real science.

Visit the BirdSleuth site ([www.birdsleuth.net/Pennington](http://www.birdsleuth.net/Pennington)) to learn more about our bird identification kits and resources.

4

### Take it Home!

Educators, keep students thinking about and observing birds at home by sending copies of the next pages (for a single two-sided copy) home with students. Invite the whole family to join the fun of watching birds!

*Print the following pages for each child to take home and let the education continue! →*

**TAKE HOME ACTIVITY**

Parents and Guardians - Your child has learned about wild birds in school, and this sheet is designed to offer more information and activities for your family to enjoy wild birds.

# WHO'S THAT... UP IN THE SKY?

Now that you know 8 types of birds, go for a walk at home and check off the birds you see using the checklist below. Determine the species if you can. If you get really into birds, start your own eBird account with your family to enter observations at home!



## Birding in Your Neighborhood

What birds are in your neighborhood? Check and see.

SPOTTED!	SILHOUETTE	SPECIES (MY BEST GUESS)





## Cool Fact!

### BRIGHT AND BROWN BIRDS

If you keep seeing brown ducks near green-headed Mallards, chances are that those are Mallards too! The green-headed birds we easily recognize as Mallards are males. Female Mallards have a brown and tan pattern, but are basically the same size and shape as the male. This is an example of sexual dimorphism, when the male and female in a species look different from one another (*di* means two and *morph* means form, so there are “two forms”).

In most sexually dimorphic species, the male is more colorful than the females because males compete for females and territory (there are few exceptions.) A brighter color can indicate that a male is healthy, good at getting food, or good at evading predators despite such obvious coloring.



## Pennington’s Habitat Helpers

Shelter. Food. Water. Help birds with Habitat Helpers that you can buy or make.



### *Pennington® 2 in 1 Bird Bath and Feeder*

This is the perfect place for birds to eat, drink, and bathe. It's made of naturally weather-resistant Eastern Red Cedar and features a removable water tray. Hardware is included and it holds up to four pounds.



## Cornell Lab’s Book of the Month AMAZING BIRDS

By Alexandra Parsons



This Eyewitness Junior book features vultures, ostriches, penguins, and all sorts of intriguing birds.

Order a copy at [www.birdsleuth.net/Pennington](http://www.birdsleuth.net/Pennington).

Visit [www.facebook.com/PenningtonBirds](http://www.facebook.com/PenningtonBirds)

# DO YOU HEAR WHAT I HEAR?



## Big Idea

Every bird sings to the typical tune of its own species. From "cheer-up" to "caw," students will be exposed to a world of bird calls and be able to describe why birds sing.

## Learning Objectives

- Students will be able to recreate the call or song of the three or more species.
- Students will be able to match at least five birds to their typical calls.
- Students will be able to describe why birds sing.

### Before You Start

Make sure you are set up to access and play audio from [www.birdsleuth.net/Pennington](http://www.birdsleuth.net/Pennington). If you are unable to access and play audio from this site during class, print out the key of birds and their song mnemonics to share with the students yourself!



## Bird of the Month!

This month's bird is the **Red-tailed Hawk**. To find them, you'll have to turn your eyes up—these hawks will often be found soaring in the sky or atop telephone poles watching for their next meal.

Visit [www.allaboutbirds.org/guide/red-tailed\\_hawk/id](http://www.allaboutbirds.org/guide/red-tailed_hawk/id) for more information and images to share with your students.

## THIS MONTH'S ACTIVITY

# 1

### Listen and Learn

In this activity you will share some bird songs with your class via sounds found at [www.birdsleuth.net/Pennington](http://www.birdsleuth.net/Pennington). Play the songs once and reveal which birds match the sounds. You can also reference the Take Home Sheet for charts of birds and their songs.

Photo Credit: Red-railed Hawk photographed by Cameron Rognan

Then, challenge your students:

- Replay some of the sounds. Can anyone remember which bird made the sound?
- Can anyone mimic any of the sounds they heard and recite any of the bird names from memory?
- Can anyone mimic all the sounds and recite the names from memory?

Follow-up questions for the class:

- How did you remember the differences in bird songs?
- In what ways were the bird songs different from one another?
- Why do you think that birds sing?

## 2

## Dawn Chorus

The dawn chorus can be heard in early morning as birds are waking up and establishing their territory and singing to attract mates.

- 1.) Have students, in groups of two or three, choose a bird song they recently learned.
- 2.) Now you will act as the conductor. To practice and allow the dawn chorus to warm up, have each bird group recite their song when you point to them.
- 3.) When each bird group is comfortable with their call, have everyone sing together to create a dawn chorus!



## Take it Outside!

To demonstrate how birds can find each other through their unique calls, keep your students in their bird species groups and have one or two students close their eyes while the rest spread out within a space the size of a tennis court. Now the closed-eyed students must find another bird in their species by listening for their fellow bird's calls. At the conclusion of the activity, ask: Why do you think that birds have distinct typical calls? How was the activity similar to birds interacting with each other in the morning?

## 4

## Take it Home!

Educators, keep students thinking about and observing birds at home by sending copies of the next pages (for a single two-sided copy) home with students. Invite the whole family to join the fun of watching birds!

*Print the following pages for each child to take home and let the education continue!* ➔



**TAKE HOME ACTIVITY**

Parents and Guardians - Your child has learned about wild birds in school, and this sheet is designed to offer more information and activities for your family to enjoy wild birds.

# DO YOU HEAR WHAT I HEAR?



## Bird Sound Matching

Go out in the morning and listen to the dawn chorus or bird songs. Open your ears and maybe even close your eyes to pinpoint different animal sounds. Write down what you hear. If you're up for a challenge, try to identify birds based on some of the sounds learned in class.

Match these birds to what they say below.

**BIRD SPECIES**

**SOUNDS LIKE**

**Black Capped Chickadee**

“hoo-oo, hoo-hoo-hoo”

**American Crow**

“chicka-dee-dee-dee”

**Mourning Dove**

“cheer-up, cheer-up”

**American Robin**

“caw, caw, caw”

**Northern Cardinal**

“wha-cheer, wha-cheer”

**Blue Jay**

“o-ka-lee, o-ka-lee”

**American Goldfinch**

“jay, jay”

**Red-winged Blackbird**

“potato-chip, potato-chip”

Listen to their calls at [www.allaboutbirds.org](http://www.allaboutbirds.org). Some birds may have more than one sound.



## Cool Fact!

### WHAT'S THAT I HEAR?

Birds use songs, calls, and other sounds for many reasons: to attract mates, to tell other birds that a predator is nearby, to communicate to family members about where they are, to declare territory, or to let other birds know where to find food.

During the breeding season, male birds sing loud songs to attract females and to warn other males to keep out of their territories. These songs are often musical. In addition to songs, birds also use a variety of calls to sound alarm, to keep track of each other, and to tell each other about food. These calls are often short and not very musical. Some birds use non-vocal sounds in place of songs or calls. For example, woodpeckers tap rhythms on tree trunks; this “drumming” may attract a mate or mark territorial boundaries.



## Pennington's Habitat Helpers

Shelter. Food. Water. Help birds with Habitat Helpers that you can buy or make.



### *Pennington® Classic Cedar Bluebird Bird House*

As the weather warms up, birds need a safe and healthy place to nest. This cedar bird house is perfect for small birds and can hold up to six babies and an adult. What's more, this house protects them from predators.

Next month: Try to make the do-it-yourself birdhouse with an adult. We'll show you how!



## Cornell Lab's Book of the Month

### BIRDSONG

By Audrey Wood

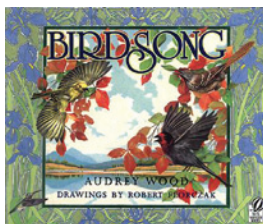

Discover the distinctive songs of eighteen different bird species indigenous to North America.

Order a copy at [www.birdsleuth.net/Pennington](http://www.birdsleuth.net/Pennington)

Visit [www.facebook.com/PenningtonBirds](https://www.facebook.com/PenningtonBirds)

# NESTS AND CHICKS!

## Big Idea

Birds build nests as a place to incubate eggs and raise young. Learning the basics about why birds build nests opens the door to understanding basic breeding biology.

## Learning Objectives

- Students will be able to describe when, where, and why birds build nests.
- Students will know what a bird's nest looks like.



### Before You Start

Visit [www.birdsleuth.net/Pennington](http://www.birdsleuth.net/Pennington), follow the Bird Cam links and make sure the streaming video functions on your browser. Additionally, if your computer is not hooked up to sound already, get access to speakers so the students can listen to the noises the birds make in the nests!



## Bird of the Month!

This month's bird is an **American Robin**. These birds are frequently seen in yards where they patiently search for worms! Their nests (with "robin blue" eggs) are common to see.

Visit [www.allaboutbirds.org/guide/American\\_Robin/id](http://www.allaboutbirds.org/guide/American_Robin/id) for more information and images to share with your students.

## THIS MONTH'S ACTIVITY

# 1

### Why Build a Nest?

Background: As egg-laying animals, birds need to provide warmth and protection while their embryos develop outside of the body. Once the eggs hatch, the young need a place to mature until they can care for themselves; that is what a nest provides. A nest is a place for incubation and parental care of young.

Ask your students:

- Why do you think birds build nests?
- Have you seen a nest before? If so,
  - Where was it?
  - What was it made out of?

Photo Credit: American Robin photographed by Cameron Rognan



With your students, make a list of locations where you expect you would find a nest and make a list of nesting materials. Once you and your students think both are complete, assess the list you've developed and ask, "Where wouldn't you find a nest?" The point of this is to teach your students that birds can nest virtually anywhere on land.

Now introduce the Nest Cams. They are a great way to teach kids about nesting birds, and to get them interested in all animals and the great outdoors. The chicks grow from nestlings (birds not ready to leave the nest) and change almost daily. Before you know it they will be fledging (ready to fly).\*

\* Some birds leave the nest right away.

## 2

## Baby Bird Run!

Establish opposite sides of your room (or outdoors) as 'true' and 'false.' Read the statements below and ask your students to move to the corresponding side. Read the answers after the statements or allow your students to try and find out the answers by watching the Nest Cams.

1. **All birds build nests.**  
False- Some don't. Brown-headed Cowbirds lay their eggs in nests of other birds.
2. **Some birds give birth to live babies rather than lay eggs.**  
False- All species of birds lay eggs.
3. **Eggs and chicks are not always safe in their nest.**  
True- Birds such as Blue Jays and crows, and other species such as chipmunks, raccoons and snakes will eat them if they find them!
4. **Most birds live in their nests year-round.**  
False- Nests are only for laying eggs and raising young.
5. **Only the female sits on the eggs.**  
False- It depends on the species.
6. **Most baby birds are fed seeds and berries by their parents.**  
False- Most birds are fed insects by their parents. Hawks and herons feed their nestlings meat for protein.
7. **Birds can breathe inside their eggs before they hatch.**  
True- Eggshells are porous enough for gases like carbon dioxide and oxygen to pass through.
8. **Eggshells are made out of the same materials as chalk.**  
True- Both are made primarily of calcium carbonate.
9. **The egg yolk (yellow) grows into a baby bird.**  
False- the yolk provides food for the growing baby bird.
10. **If you find a baby bird you should feed it bread and milk.**  
False- Birds cannot digest milk and bread will not help them! If you find a nestling put it back in the nest, and if you find a fledgling leave it alone! It is just practicing being out of the nest.

3

### Take it Outside!

Have students build their own “nest” from natural materials they gather outside, or that you provide: sticks, tiny twigs, leaves, mud, pine needles, dried grass, plant fluff (cattails, milkweed seeds, etc.). They can test their nest’s ability to hold “eggs” by putting 2-3 small rocks in the nest and then placing it on a y-shaped tree branch. If any nests are well-made, but don’t seem strong enough to pass the test, perhaps they are for ground-nesting birds!

Visit the BirdSleuth site ([www.birdsleuth.net/Pennington](http://www.birdsleuth.net/Pennington)) to learn more about our bird identification kits and resources.

4

### Take it Home!

Educators, keep students thinking about and observing birds at home by sending copies of the next pages (for a single two-sided copy) home with students. Invite the whole family to join the fun of watching birds!

*Print the following pages for each child to take home and let the education continue! ➔*

**TAKE HOME ACTIVITY**

Parents and Guardians - Your child has learned about wild birds in school, and this sheet is designed to offer more information and activities for your family to enjoy wild birds.

# NESTS AND CHICKS!



## Baby Bird Dos and Don'ts

At home, show the Nest Cams (<http://watch.birds.cornell.edu/nestcams/home/index>)! What can you remember from school that you can share? While watching the cameras, look at how the parent birds interact with the young in the nest. Are they resting or is it feeding time? Have fun watching the cameras and talk about what you see! If there are any nests nearby, you can report it to NestWatch ([www.nestwatch.org](http://www.nestwatch.org)). This is a great way to continue being active in Citizen Science.

Here are some FAQs to share with friends and family.

**Q. If you find a baby bird on the ground, what do you feed it?**

A. Don't feed it anything. Humans cannot provide the things baby birds need. But don't worry! The vast majority of "abandoned" baby birds are perfectly healthy fledglings and all you need to do is place it back in its nest.

**Q. If I handle a baby bird, will its parents pick up my scent and abandon it?**

A. Fortunately, that's just a myth. Parent birds don't recognize young by smell; most birds don't have a good sense of smell.

**Q. Why do birds leave the nest before they can fly?**

A. Usually, it's to their advantage to leave as soon as they can. Predators can easily find a nest full of squawking baby birds and nests can host parasites. Parent birds work very hard to get their young out of the nest as quickly as possible.

**Q. I unintentionally spooked a nesting mother. She flew away and hasn't returned. Should I try to hatch the eggs myself?**

A. Unless you're an expert, hatching eggs is a very delicate process! The right equipment and conditions are essential for hatching eggs. The temperature and humidity must be exactly right and the eggs must be rotated periodically. In these cases, the best solution is to call your local nature center. They should have the proper incubators or local knowledge to know how to deal with the situation.

Visit Project NestWatch at [www.nestwatch.org](http://www.nestwatch.org) to observe nests, incubation, hatching, and first flights.



## Cool Fact!

### EXTREME NESTS

Birds do not live year-round in nests! Nests are only for incubating eggs and raising chicks. Some nests aren't made of leaves and twigs—some are burrows in the ground, some are holes in trees, and some are just round depressions in the sand. Nests can come in many sizes and shapes. Several hummingbird species have nests about an inch in diameter, which is around the size of a nickel. The record for largest nest goes to a Bald Eagle nest, which measured around 9 feet wide and 20 feet tall! Bald Eagles will keep building on top of their old nests every year.



## Pennington's Habitat Helpers

Shelter. Food. Water. Help birds with Habitat Helpers that you can buy or make.



### Nesting Box

There are many kinds of nest boxes to buy or build online. Search [nestwatch.org](http://nestwatch.org) to find the proper nest box plans for many of your local species.



## Cornell Lab's Book of the Month

### BIRDS BUILD NESTS

By Yvonne Winer

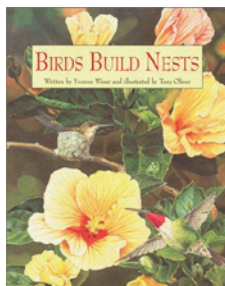

Learn about the nesting materials that birds use and the places where they build their nests, presented in a beautiful blend of science, illustration, and poetry. *Birds Build Nests* explores nests found all over the world.

Learn more at [www.birdsleuth.net/Pennington](http://www.birdsleuth.net/Pennington).

Visit [www.facebook.com/PenningtonBirds](http://www.facebook.com/PenningtonBirds)